

### Features

- Wide input voltage range: 1.5V – 6V
- Low  $R_{DS(ON)}$ : 80m $\Omega$  typical @ 5V
- Turn-on slew rate controlled
- AP2281-1: 1ms turn-on rise time
- AP2281-3: 100us turn-on rise time with internal discharge
- Very low turn-on quiescent current:  $\ll$  1uA
- Fast load discharge option
- Temperature range -40°C to 85°C
- SOT26 and DFN2018-6: Available in "Green" Molding Compound (No Br, Sb)
- Lead Free Finish/ RoHS Compliant (Note 1)

### Description

The AP2281 slew rate controlled load switch is a single P-channel MOSFET power switch designed for high-side load-switching applications. The MOSFET has a typical  $R_{DS(ON)}$  of 80m $\Omega$  at 5V, allowing increased load current handling capacity with a low forward voltage drop. The turn-on slew rate of the device is controlled internally.





The AP2281 load switch is designed to operate from 1.5V to 6V, making it ideal for 1.8V, 2.5V, 3.3V, and 5V systems. The typical quiescent supply current is only 0.01uA.

### Applications

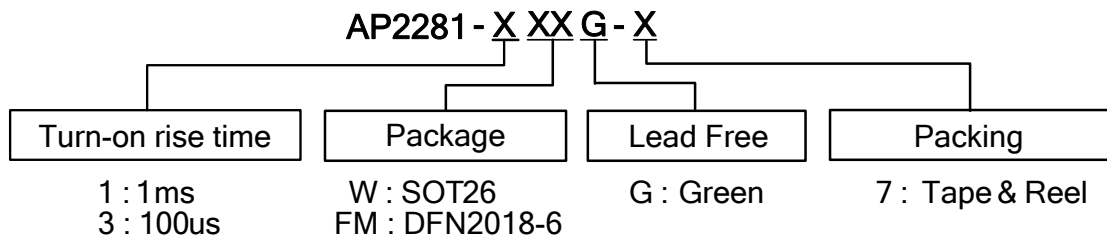
- Smart Phones
- PDA
- Cell Phones
- GPS Navigators
- PMP/MP4
- Notebook and Pocket PC

### Ordering Information



Device	Package Code	Packaging (Note 2)	7" Tape and Reel	
			Quantity	Part Number Suffix
 AP2281-1WG-7	W	SOT26	3000/Tape & Reel	-7
 AP2281-3WG-7	W	SOT26	3000/Tape & Reel	-7
 AP2281-1FMG-7	FM	DFN2018-6	3000/Tape & Reel	-7
 AP2281-3FMG-7	FM	DFN2018-6	3000/Tape & Reel	-7

Notes: 1. EU Directive 2002/95/EC (RoHS). All applicable RoHS exemptions applied, see *EU Directive 2002/95/EC Annex Notes*.  
 2. Pad layout as shown on Diodes Inc. suggested pad layout document AP02001, which can be found on our website at <http://www.diodes.com/datasheets/ap02001.pdf>

### Pin Assignments

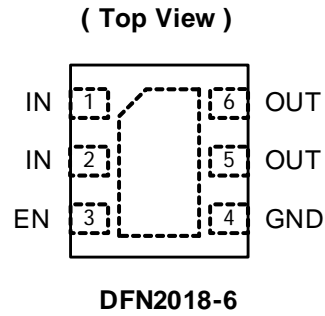
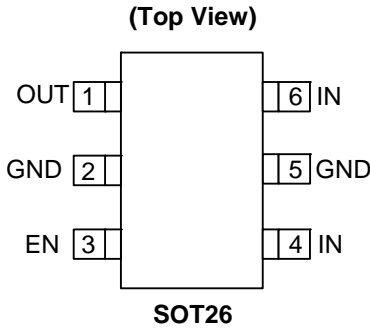

### Pin Description

Pin Name	Pin Number		Description
	SOT26	DFN2018-6	
OUT	1	5, 6	Voltage output pin. This is the pin to the P-channel MOSFET drain connection. Bypass to ground through a 0.1uF capacitor.
GND	2, 5	4	Ground.
EN	3	3	Enable input, active high
IN	4, 6	1, 2	Voltage input pin. This is the pin to the P-channel MOSFET source. Bypass to ground through a 1µF capacitor.

### Options

Part Number	Slew Rate (typ)	Active pull down	Enable
AP2281-1	1ms	no	Active high
AP2281-3	100us	yes	Active high

**Block Diagram**

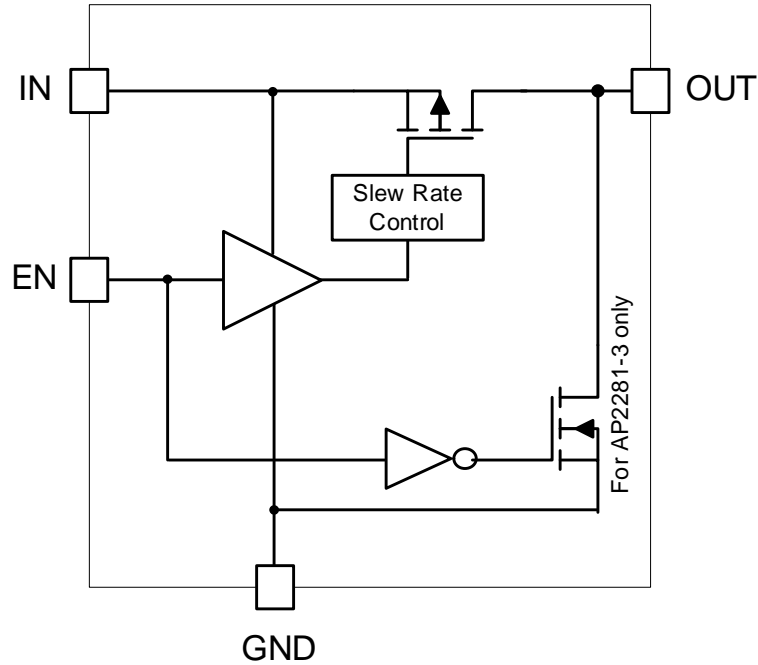

**Typical Application Circuit**

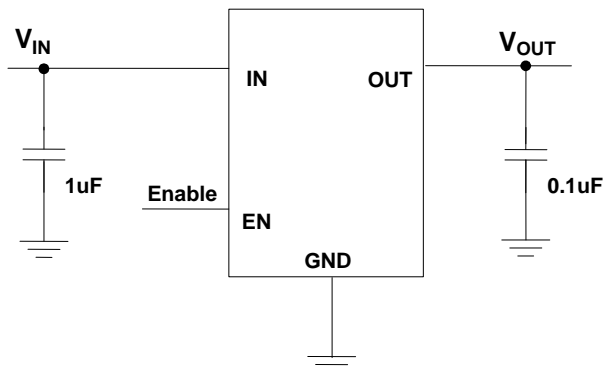

### Absolute Maximum Ratings

Symbol	Parameter		Ratings	Unit
ESD HBM	Human Body Model ESD Protection		5	KV
ESD MM	Machine Model ESD Protection	SOT26	500	V
		DFN2018-6	450	V
$V_{IN}$	Input Voltage		6.5	V
$V_{OUT}$	Output Voltage		$V_{IN} + 0.3$	V
$V_{EN}$	Enable Voltage		6.5	V
$I_{load}$	Maximum Continuous Load Current		2	A
$T_J$	Operating Junction Temperature Range		-40 ~ 125	°C
$T_{ST}$	Storage Temperature Range		-65 ~ 150	°C
$P_D$	Power Dissipation	SOT26 (Note 3, 4, 5)	720	mW
		DFN2018-6 (Note 3, 4, 6)	1410	mW

Notes: 3.  $T_J$ , max = 125°C.

4. Ratings apply to ambient temperature at 25°C.

### Recommended Operating Conditions

Symbol	Parameter	Min	Max	Unit
$V_{IN}$	Input voltage	1.5	6.0	V
$I_{OUT}$	Output Current	0	2.0	A
$T_A$	Operating Ambient Temperature	-40	85	°C

### Electrical Characteristics

( $T_A = 25^\circ\text{C}$ ,  $V_{IN} = 5.0\text{V}$ , unless otherwise stated)

Symbol	Parameters	Test Conditions	Min	Typ.	Max	Unit
$I_Q$	Input Quiescent Current	$V_{EN} = V_{IN}$ , $I_{OUT} = 0$	—	0.01	1	$\mu\text{A}$
$I_{SHDN}$	Input Shutdown Current	$V_{EN} = 0\text{V}$ , OUT open	—	0.01	1	$\mu\text{A}$
$I_{LEAK}$	Input Leakage Current	$V_{EN} = 0\text{V}$ , OUT grounded	—	0.01	1	$\mu\text{A}$
$R_{DS(ON)}$	Switch on-resistance	$V_{IN} = 5.0\text{V}$		80	100	$\text{m}\Omega$
		$V_{IN} = 3.3\text{V}$		95	120	$\text{m}\Omega$
		$V_{IN} = 1.8\text{V}$		160	210	$\text{m}\Omega$
		$V_{IN} = 1.5\text{V}$		210	280	$\text{m}\Omega$
$V_{IL}$	EN Input Logic Low Voltage	$V_{IN} = 1.5\text{V}$ to $6\text{V}$			0.4	V
$V_{IH}$	EN Input Logic High Voltage	$1.5\text{V} \leq V_{IN} \leq 2.7\text{V}$	1.4			V
		$2.7\text{V} < V_{IN} < 5.25\text{V}$	1.6			V
		$V_{IN} \geq 5.25\text{V}$	1.7			V
$I_{SINK}$	EN Input leakage	$V_{EN} = 5\text{V}$	—		1	$\mu\text{A}$
$T_{D(ON)}$	Output turn-on delay time	$R_{load} = 10\Omega$		1		$\mu\text{S}$
$T_{ON}$	Output turn-on rise time	AP2281-1, $R_{load} = 10\Omega$		1000	1500	$\mu\text{S}$
		AP2281-3, $R_{load} = 10\Omega$		100	150	$\mu\text{S}$
$T_{D(OFF)}$	Output turn-off delay time	$R_{load} = 10\Omega$		0.5	1	$\mu\text{S}$
$R_{DISCH}$	Discharge FET on-resistance	For AP2281-3 only, $V_{EN} = \text{GND}$		65	100	$\Omega$
$\theta_{JA}$	Thermal Resistance Junction-to-Ambient	SOT26 (Note 5)		153		$^\circ\text{C}/\text{W}$
		DFN2018-6 (Note 6)		78		$^\circ\text{C}/\text{W}$
$\theta_{JC}$	Thermal Resistance Junction-to-case	SOT26 (Note 5)		29		$^\circ\text{C}/\text{W}$
		DFN2018-6 (Note 6)		19		$^\circ\text{C}/\text{W}$

Notes: 5. Test condition for SOT26: Device mounted on FR-4 substrate PC board, 2oz copper, with minimum recommended pad layout.

6. Test condition for DFN2018-6: Device mounted on FR-4 2-layer board, 2oz copper, with minimum recommended pad on top layer and 3 vias to bottom layer 1.0"x1.4" ground plane.

**Typical Performance Characteristics**

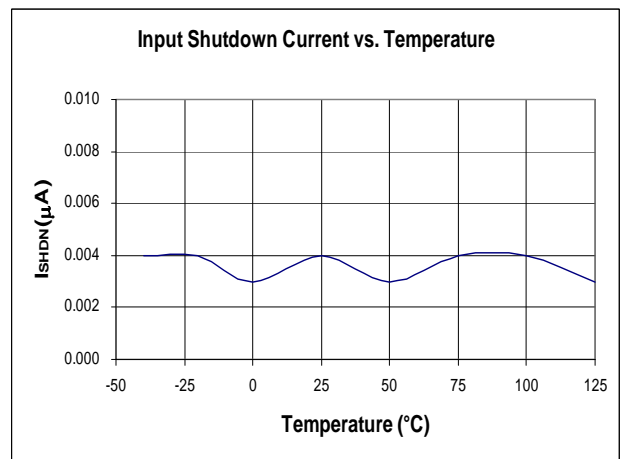
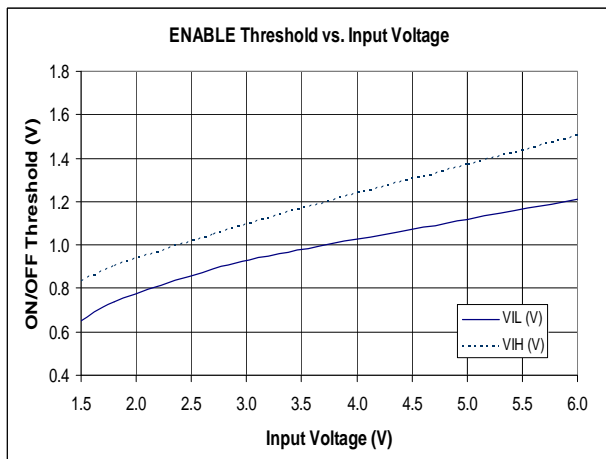
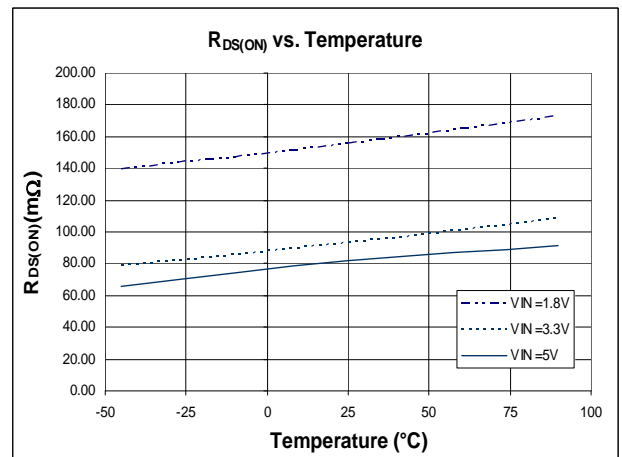
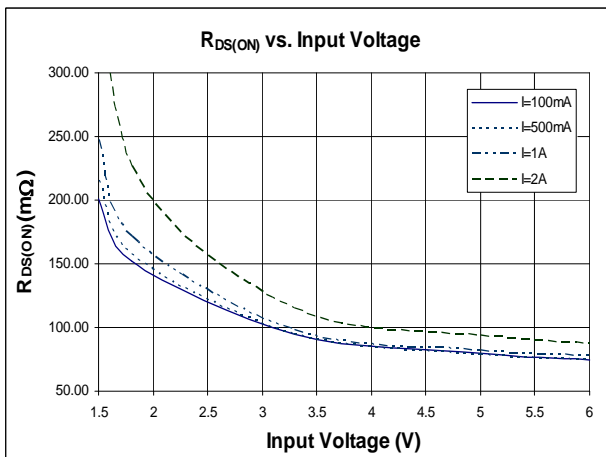
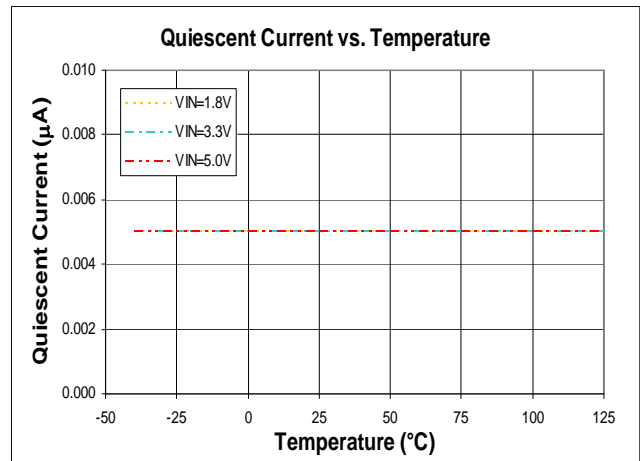
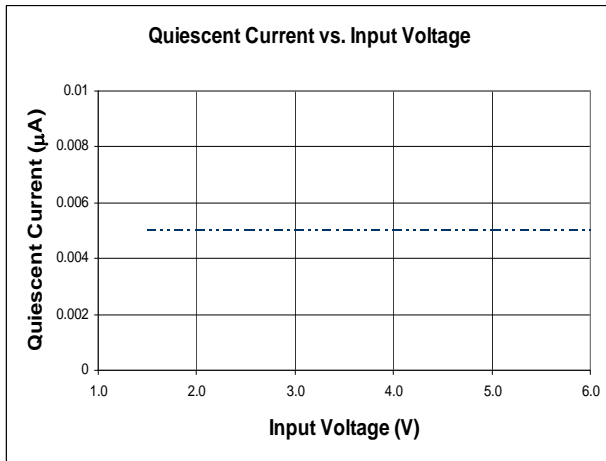

**Typical Performance Characteristics (Continued)**

**AP2281-1 Turn-On**  
( $V_{IN}=3.3V$ ,  $R_L=7\Omega$ )

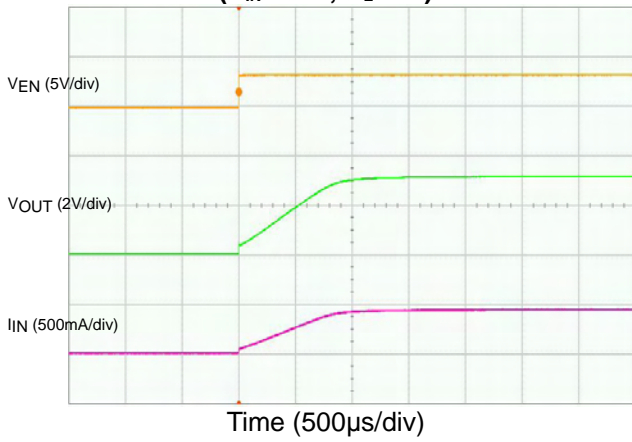

**AP2281-1 Turn-Off**  
( $V_{IN}=3.3V$ ,  $R_L=7\Omega$ )

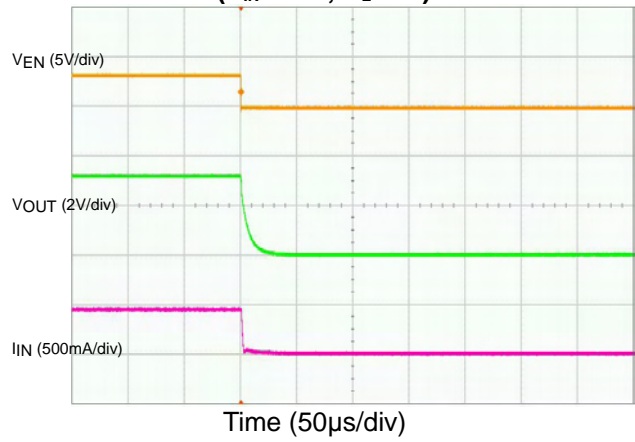

**AP2281-1 Turn-On**  
( $V_{IN}=5V$ ,  $R_L=10\Omega$ )

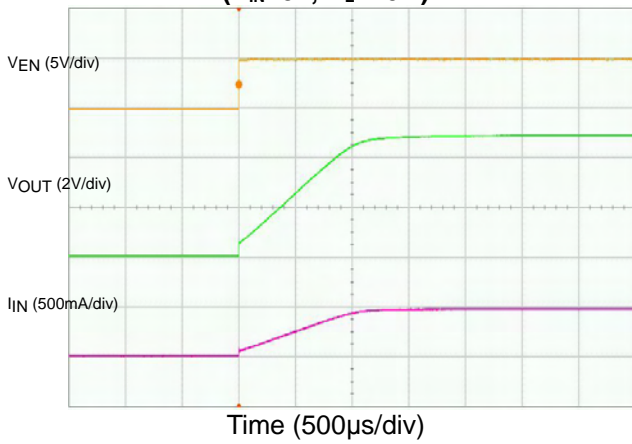

**AP2281-1 Turn-Off**  
( $V_{IN}=5V$ ,  $R_L=10\Omega$ )

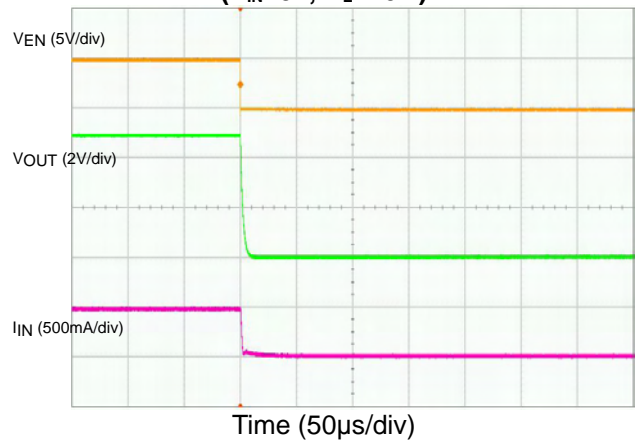

**Typical Performance Characteristics (Continued)**

**AP2281-3 Turn-On**  
( $V_{IN}=3.3V$ ,  $R_L=7\Omega$ )

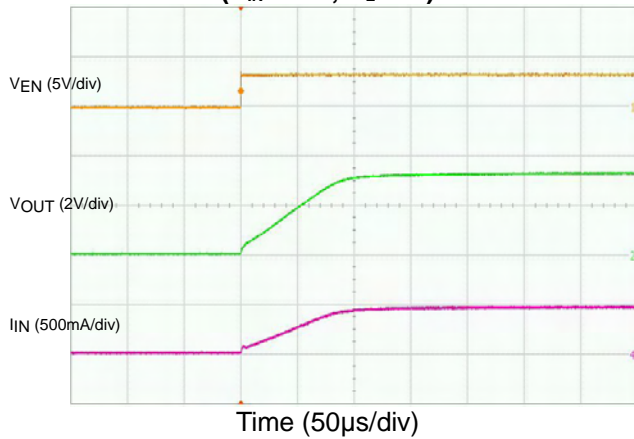

**AP2281-3 Turn-Off**  
( $V_{IN}=3.3V$ ,  $R_L=7\Omega$ )

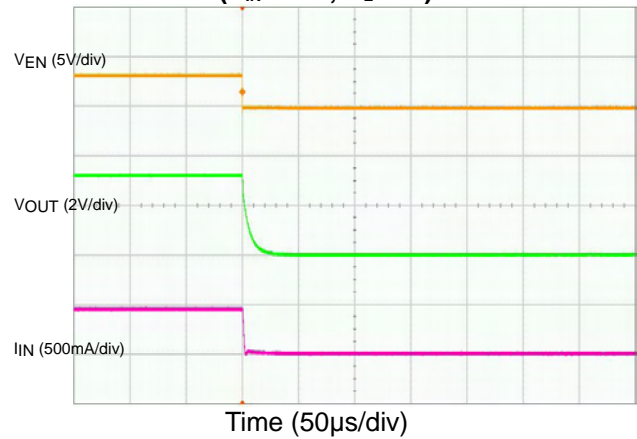

**AP2281-3 Turn-On**  
( $V_{IN}=5V$ ,  $R_L=10\Omega$ )

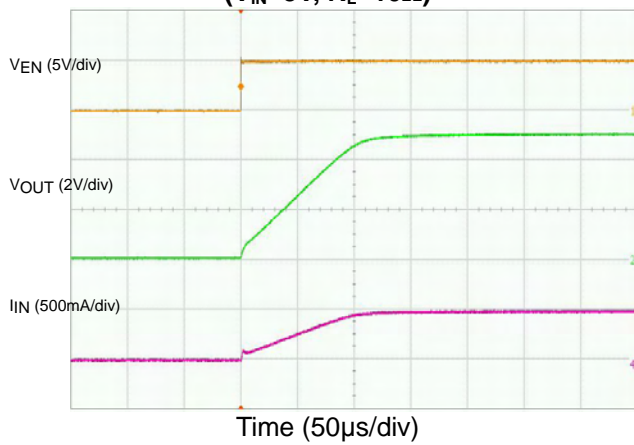

**AP2281-3 Turn-Off**  
( $V_{IN}=5V$ ,  $R_L=10\Omega$ )

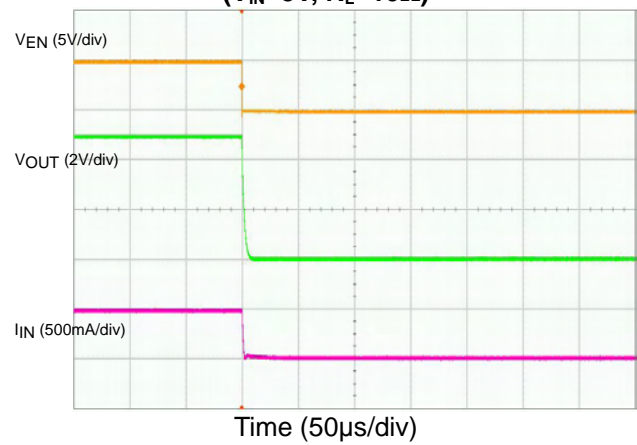



---

## Application Note

---

### Input Capacitor

A 1 $\mu$ F capacitor is recommended to connect between IN and GND pins to decouple input power supply glitch and noise. The input capacitor has no specific type or ESR (Equivalent Series Resistance) requirement. However, for higher current application, ceramic capacitors are recommended due to their capability to withstand input current surges from low impedance sources, such as batteries in portable applications. This input capacitor must be located as close as possible to the device to assure input stability and less noise. For PCB layout, a wide copper trace is required for both IN and GND.

### Output Capacitor

A 0.1 $\mu$ F capacitor is recommended to connect between OUT and GND pins to stabilize and accommodate load transient condition. The output capacitor has no specific type or ESR requirement. The amount of the capacitance may be increased without limit. For PCB layout, the output capacitor must be placed as close as possible to OUT and GND pins, and keep the traces as short as possible.

### ENABLE/SHUTDOWN Operation

The AP2281 is turned on by setting the EN pin high, and is turned off by pulling it low. To ensure proper operation, the signal source used to drive the EN pin must be able to swing above and below the specified turn-on/off voltage thresholds listed in the Electrical Characteristics section under  $V_{IL}$  and  $V_{IH}$ .

### DISCHARGE Operation

The AP2281-3 offers discharge option that helps to discharge the output charge when disabled.

### Power Dissipation

The device power dissipation and proper sizing of the thermal plane is critical to avoid thermal shutdown and ensure reliable operation. Power dissipation of the device depends on input voltage and load conditions and can be calculated by:

$$P_D = I_{OUT}^2 \times R_{DS(ON)} \quad (1)$$

However, the maximum power dissipation that can be handled by the device depends on the maximum junction to ambient thermal resistance, maximum ambient temperature, and maximum device junction temperature, which can be approximated by the equation below:

$$P_D (\text{max @ } T_A) = \frac{(+125^\circ\text{C} - T_A)}{\theta_{JA}} \quad (2)$$

For example at  $V_{IN} = 5\text{V}$ , the typical  $R_{DS(ON)} = 80\text{m}\Omega$ . For  $I_{OUT} = 2\text{A}$ , the maximum power dissipation calculated using equation (1) is  $P_D = 0.32\text{W}$ . Based on SOT26  $\theta_{JA} = 153^\circ\text{C/W}$  and equation (2), the calculated junction temperature rise from ambient is approximately  $49^\circ\text{C}$ . Since the maximum junction temperature is  $125^\circ\text{C}$ , the operating ambient temperature must be kept below  $76^\circ\text{C}$  to safely operate the device.

On the other hand, at  $T_A = 85^\circ\text{C}$  and  $V_{IN} = 5\text{V}$ , the calculated maximum power dissipation from equation (2) is approximately  $P_{Dmax} = 0.26\text{W}$ . Hence the safe operating maximum continuous current is  $1.81\text{A}$ . For other application conditions, the users should recalculate the device maximum power dissipation based on the operating conditions.

**Marking Information**

(1) SOT26

(2) DFN2018-6

(Top View)

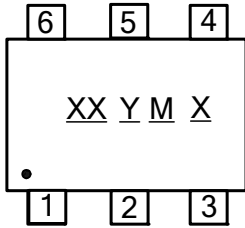

XX : U2 : AP2281-1  
 U3 : AP2281-3  
Y : Year : 0-9  
M : Month : A~L  
X : A~Z : Green

(Top View)

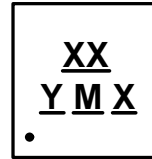

XX : UE : AP2281-1  
 UF : AP2281-3  
Y : Year 0~9  
M : Month A~L  
X : A~Z : Green

**Package Information**

(1) Package Type: SOT26

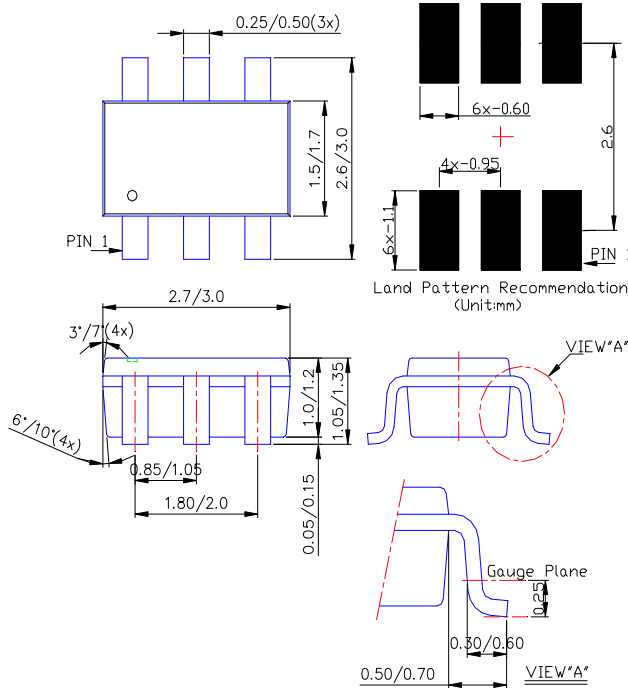

**Package Information (Continued)**

**(2) Package type: DFN2018-6**

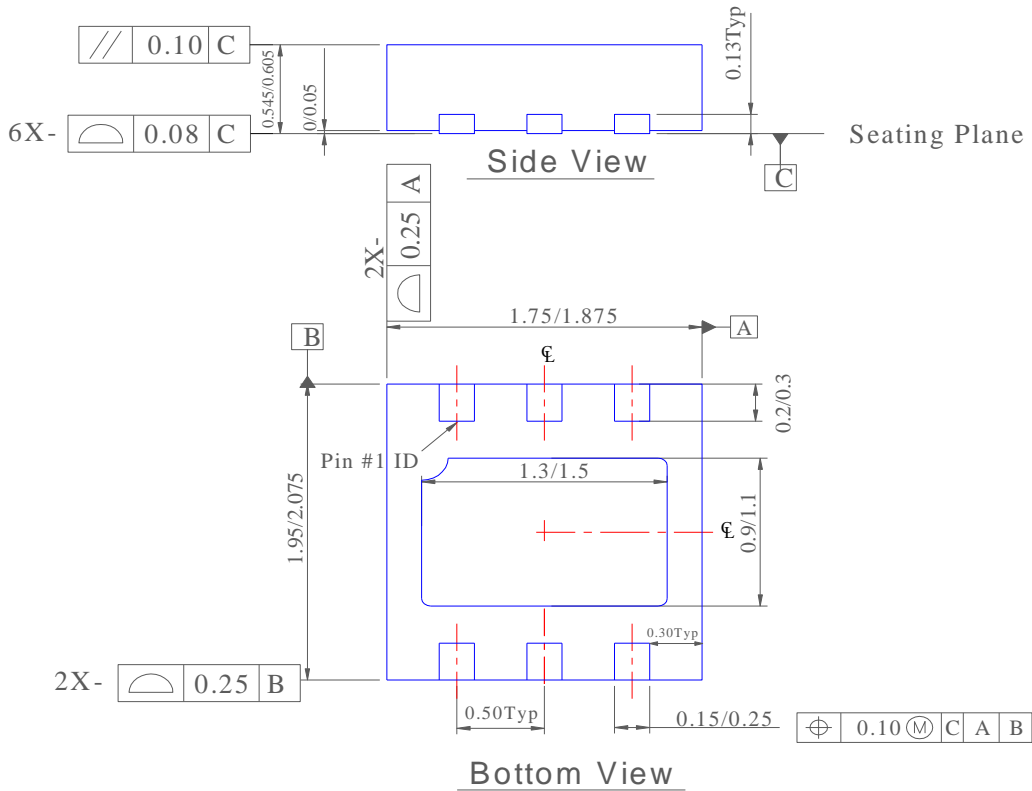

**Taping Orientation**

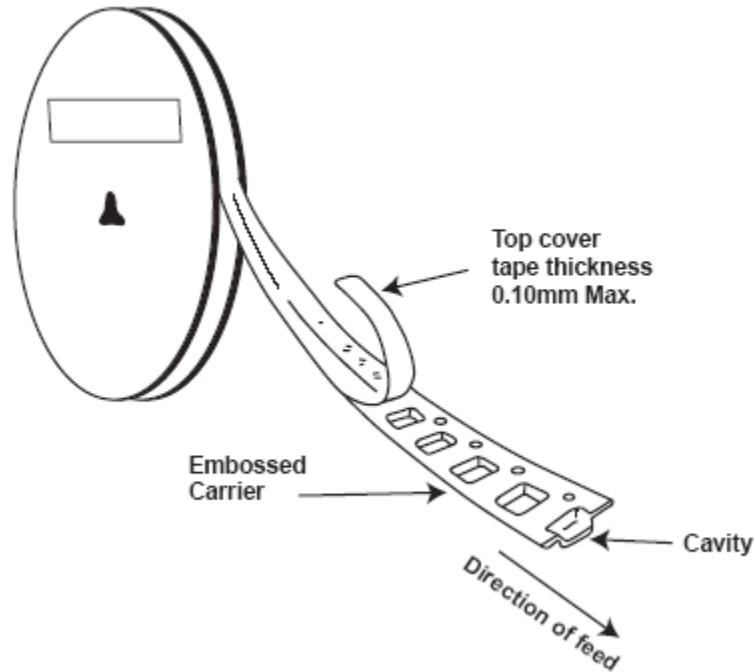
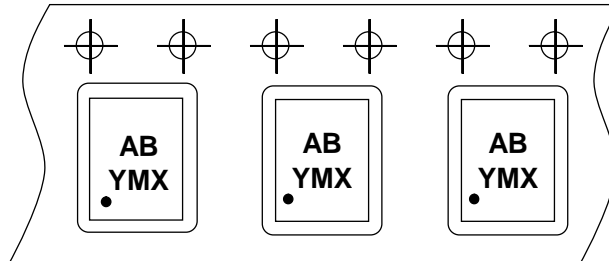

Notes: 7. The taping orientation of the other package type can be found on our website at <http://www.diodes.com/datasheets/ap02007.pdf>

**IMPORTANT NOTICE**

Diodes Incorporated and its subsidiaries reserve the right to make modifications, enhancements, improvements, corrections or other changes without further notice to any product herein. Diodes Incorporated does not assume any liability arising out of the application or use of any product described herein; neither does it convey any license under its patent rights, nor the rights of others. The user of products in such applications shall assume all risks of such use and will agree to hold Diodes Incorporated and all the companies whose products are represented on our website, harmless against all damages.

**LIFE SUPPORT**

Diodes Incorporated products are not authorized for use as critical components in life support devices or systems without the expressed written approval of the President of Diodes Incorporated.